

21. júní kl.10-núv. deiliskipulag skv. skilmálasniði A2

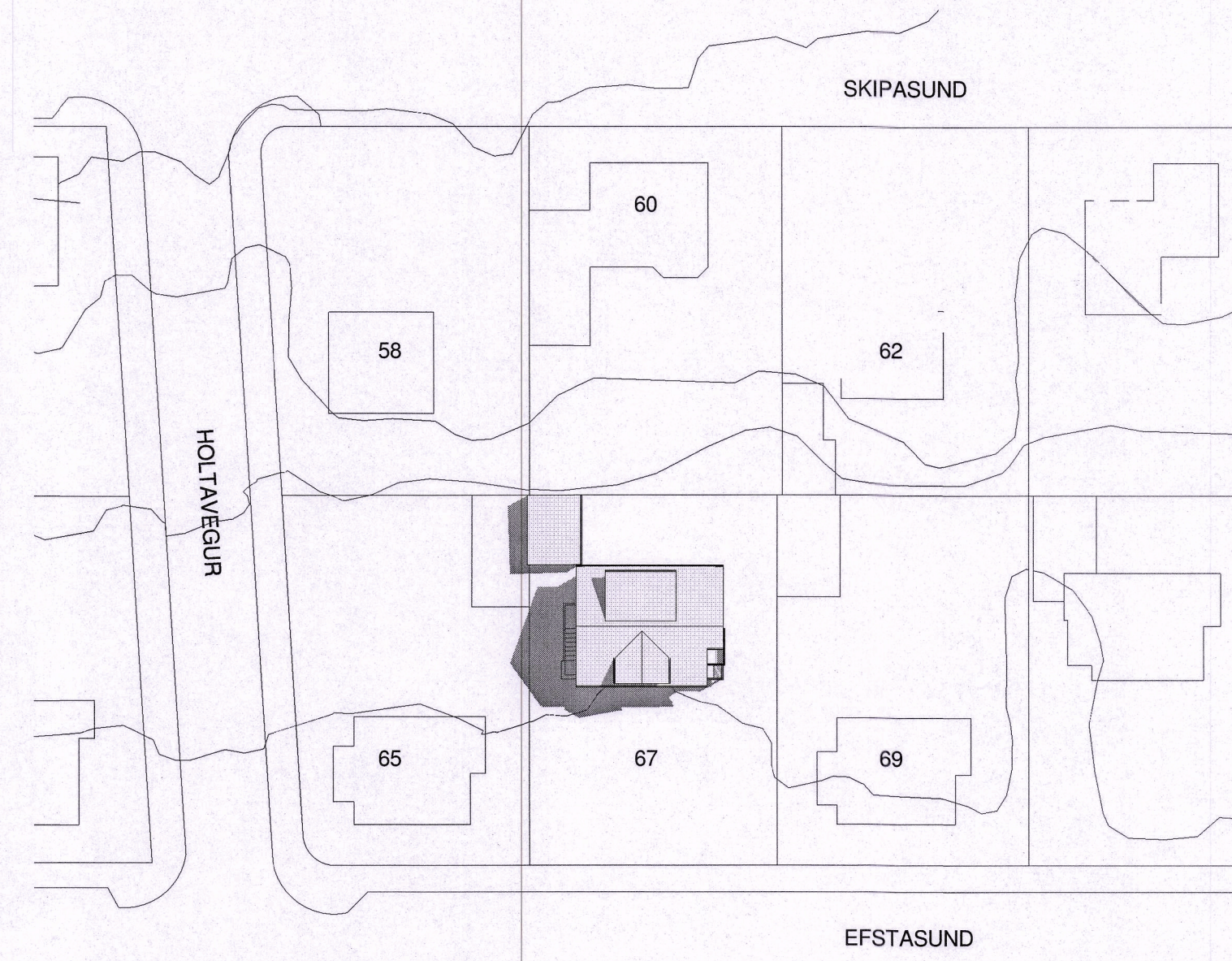

21. júní kl.10- deiliskipulag f. Efstasund 67, nýtt skilmálasnið

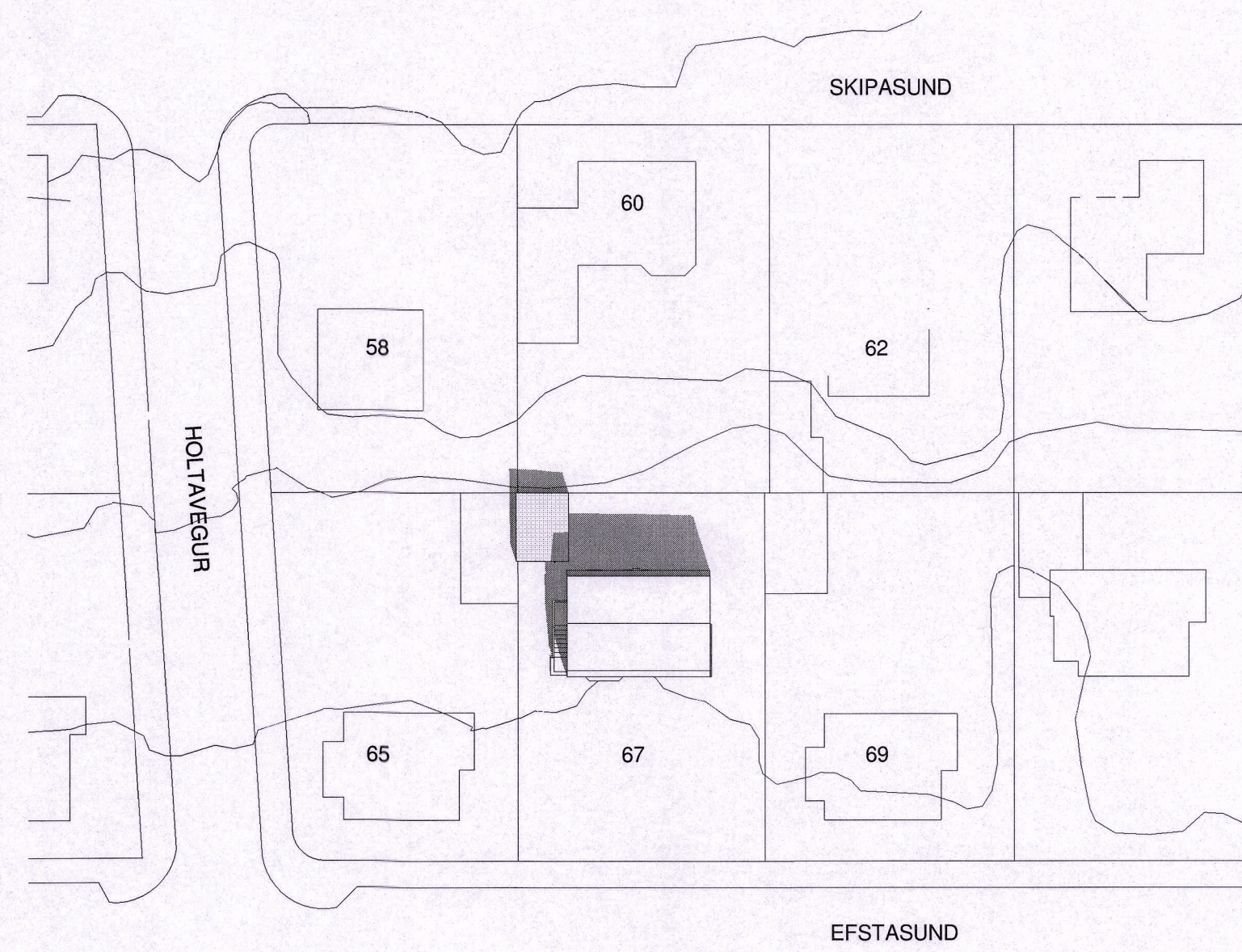

21. júní kl.14-núv. deiliskipulag skv. skilmálasniði A2

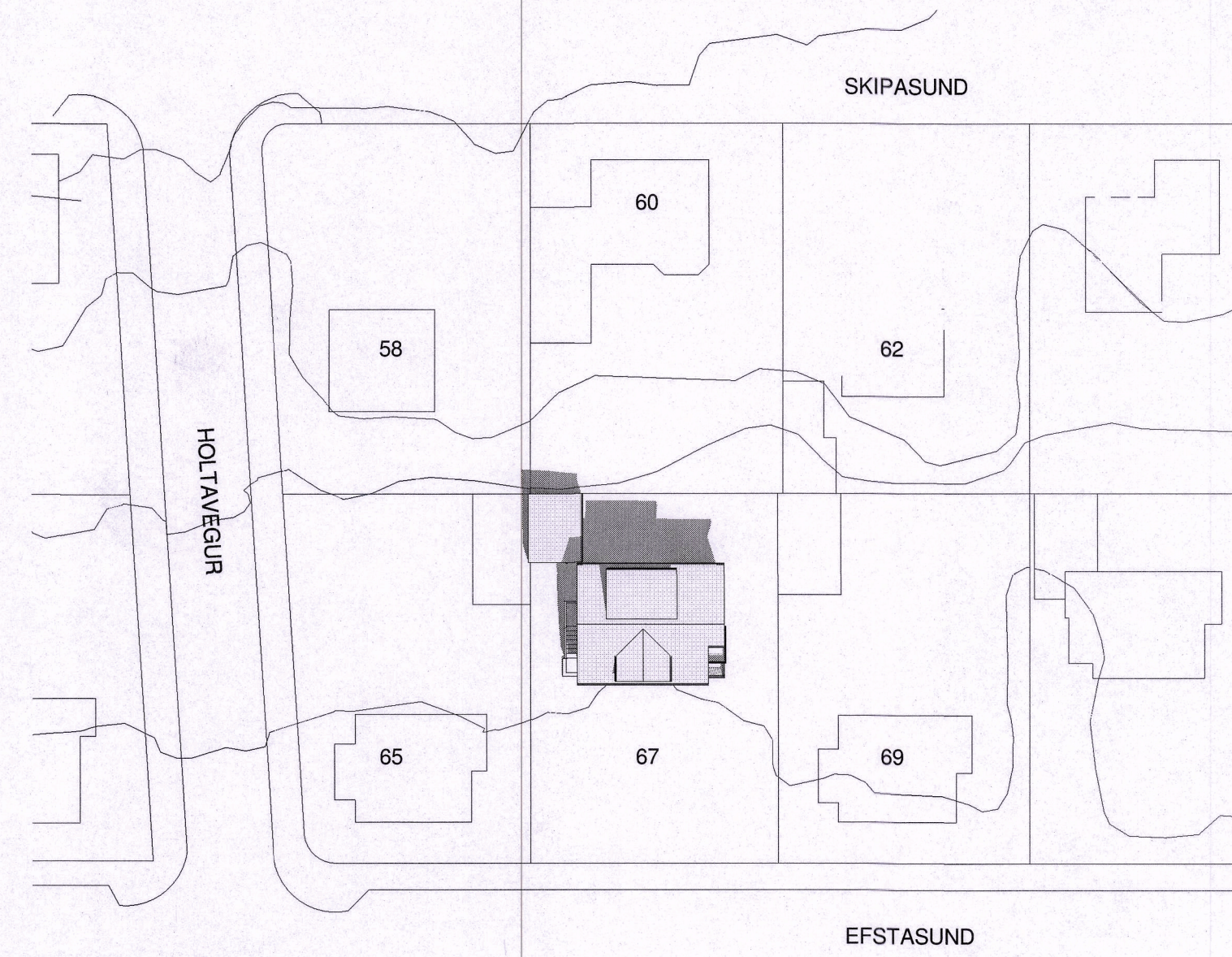

21. júní kl.14- deiliskipulag f. Efstasund 67, nýtt skilmálasnið

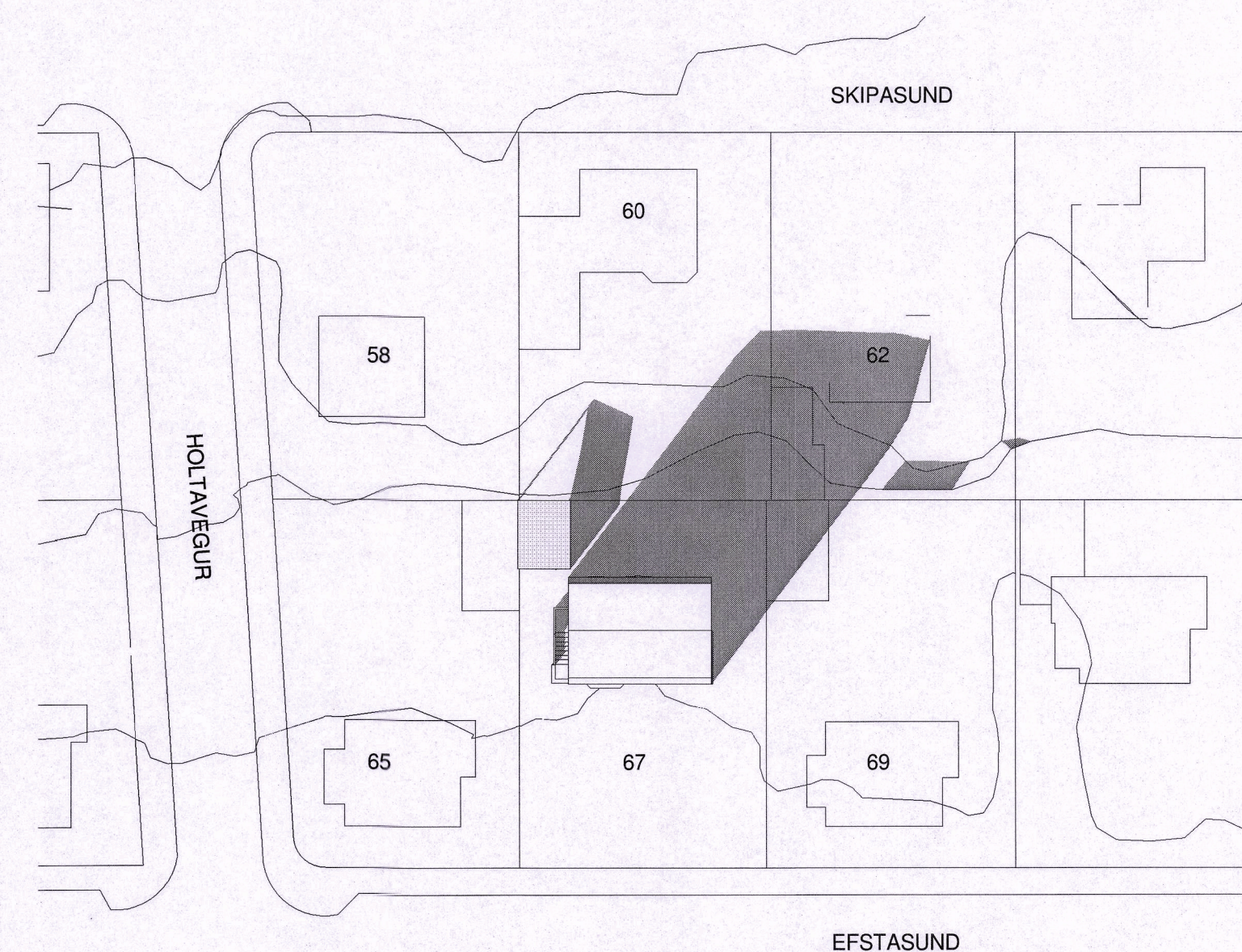

21. júní kl.18-núv. deiliskipulag skv. skilmálasniði A2

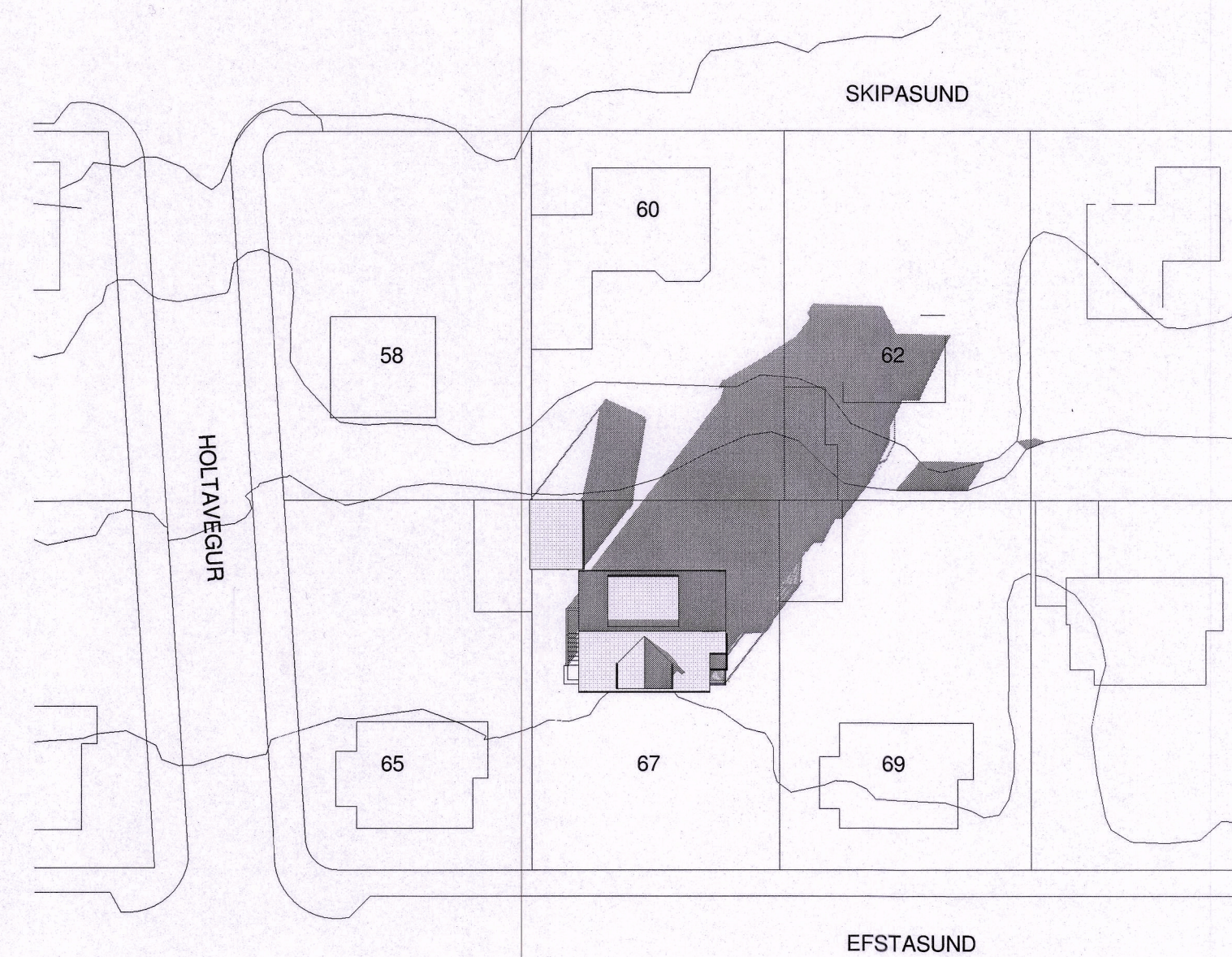

21. júní kl.18-deiliskipulag f. Efstasund 67, nýtt skilmálasnið

Landhæðir mibast við hæðarlínur í Borgarvefsjá. Skuggavarp tekur mið af landhæðum.

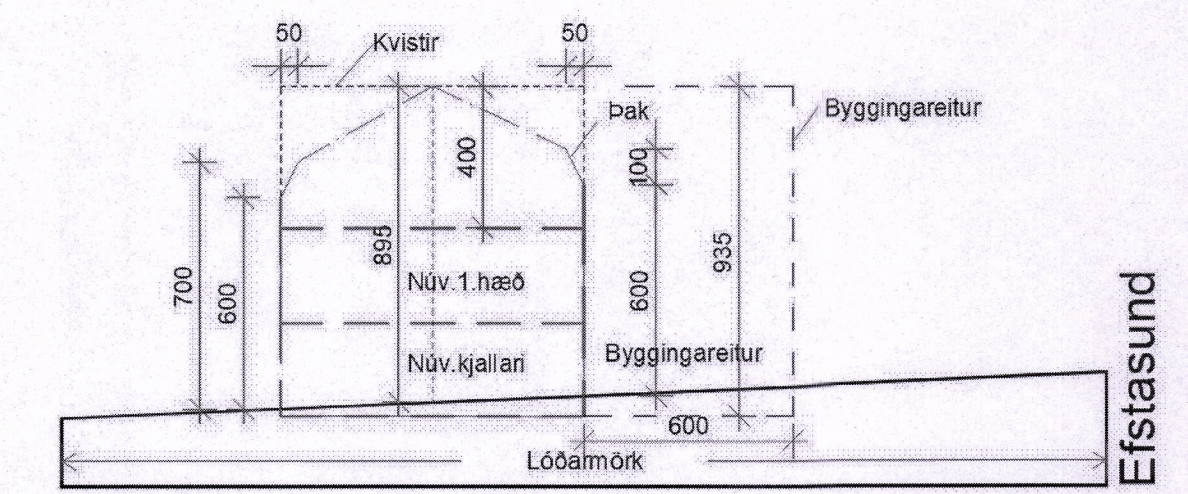
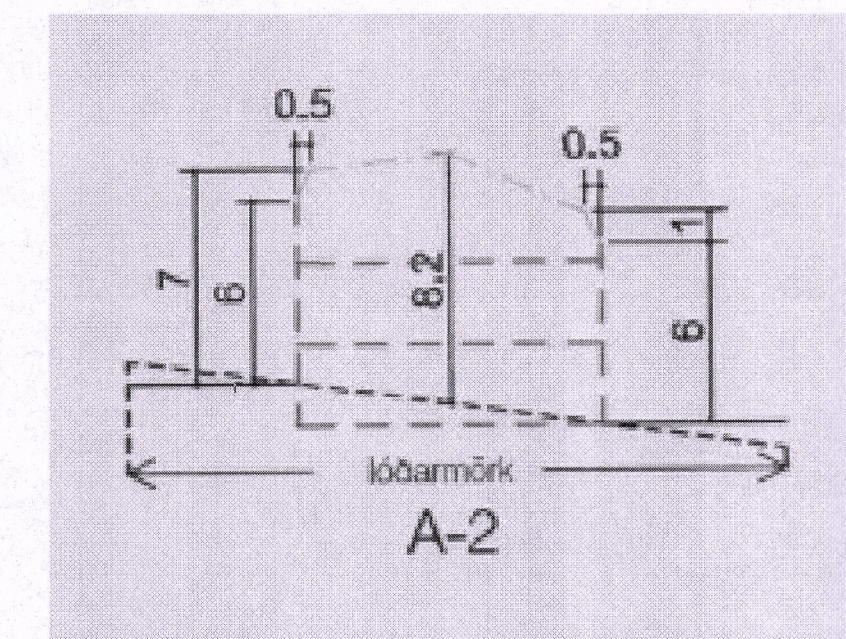

Skilmálasnið lóðar nr. 67

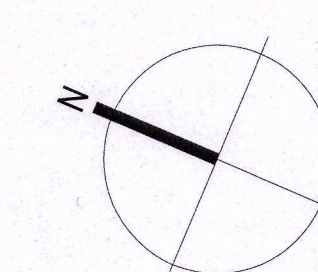

BREYTT			
HEITI VERKS:			
EFSTASUND 67			
HEITI TEKINGAR:			
SKIPULAG			
SKUGGAVARP- LENGSTI DAGUR ÁRSINS			
DAGS:	10.08.2021	HAUNAD:	JL / KÁ
YPRF:	JL	TEKNAÐ:	SJ
VERKNR.:	...	KVARDI:	1:500
DALVEGI 18		ALARK	
201 KOPAVOGI		arkitektar ehf.	
SÍM: 224 8800		www.alark.is	
FAX: 224 8918		A109	
KT: 501183-2009			
JAKOB EMBL LINDAL			
KRISTIAN AUGUSTSSON			
ARKITEKT P/F KT: 50099-2020			
KRISTIAN AUGUSTSSON			